

CX14 (II ED.) AC EVO AGM 800X525

BEST PERFORMANCE IN ITS CATEGORY



ELECTRIC PALLET TRUCK - CX14

The new CX14 electric pallet trucks are compact, lightweight and easy to use. They have been specifically designed for use in confined spaces within rail, shops, supermarkets and on-board delivery vehicles. These simple and efficient pallet trucks are built to last and are perfect for all your pedestrian material handling needs.

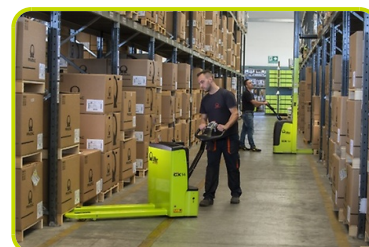

CX14 EVO AGM

The EVO version is equipped with powerful batteries AGM deep cycles, the biggest in the category, which ensure longer endurance and greater number of charging cycles. It is built with an ergonomic tiller that offers a comfortable grip and includes battery status indicator with hour meter. The new permanent magnetic AC drive system increases the performance, reduces sound emissions and minimises energy consumption as well as maintenance costs.



24V / 85Ah



6/6 km/h



kg
1400 kg



115 mm

MANOEUVRABILITY

- Short chassis dimension (L2 = 410 mm) to offer improved manoeuvrability in confined spaces.
- Compact design perfect for working in narrow areas and corridors, featuring a tighter turning radius (Wa = 1345 mm) for faster pinwheeling and easier navigation in congested spaces.
- Smooth rounded fork tips and entry/exit rollers to optimize pallet handling.



RELIABILITY

- Robust frame (metal motor wheel protection 6 mm thick) designed to guarantee maximum durability and resistance to torsion and heavy loads.
- Battery discharge indicator to allow easy management.
- Easy access to electrical components for maintenance.

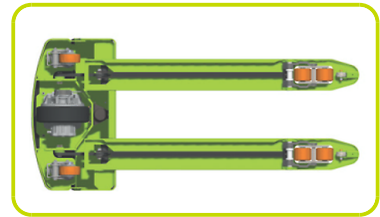

PRODUCTIVITY

- Strong ABS cover with storage tray on top, easily removable for simple access to batteries and key components speeding-up maintenance operations.
- BOOST switch allows two levels of travel speed (up to 6 km/h) according to operator experience and application environment.
- Easy access to the motorwheel components through dedicated inspection opening.
- Schuko plug with spiral cable and on board battery charger.



INTELLIGENT TILLER

- Ergonomic tiller designed for both left and right handed operation.
- Butterfly valves for traction control.
 - Safety push button with warning buzzer.
 - Forks way up/down control positioned on both sides of the handle and BOOST button.
 - Turtle function for moving in tight areas with the handle in vertical position while remaining almost within the profile of the machine.



ON-BOARD BATTERY CHARGER

Built-in battery charger provides a convenient charging solution and eliminates the need to remove the battery from the machine.



TRACTION & SAFETY

Traction is granted by the biggest heavy-duty stabilizer wheels (100x40 mm) in the category, with heavy duty spring. All linkage connection done through bushings that increase stability and durability.

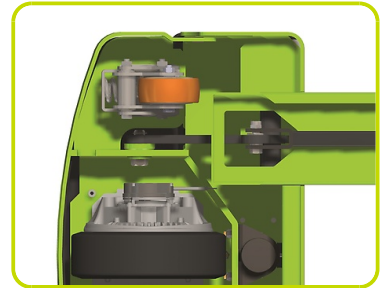

ROLLERS

Standard configuration provided with single polyurethane rollers. Available tandem rollers as optional.



Kennzeichen

1.1 Hersteller			PR INDUSTRIAL
Lift			Elektrisch
1.3 Antrieb			Elektrisch
1.4 Bedienung			Begleitend
1.5 Tragfähigkeit	Q	Kg	1400
1.6 Lastschwerpunkt	c	mm	400
1.8 Lastabstand	x	mm	585
1.9 Radstand	y	mm	846

Gewicht

2.1 Eigengewicht (inkl. Batterie)		Kg	247
2.2 Achslast mit Last hinten		Kg	1138
2.2 Achslast, mit Last vorne		Kg	510
2.3 Achslast mit Last vorne		Kg	200
2.3 Achslast mit Last hinten		Kg	47

Fahrwerk/Räder

3.1 Räder: Lenkräder			Gummi
3.1 Bereifung: Stützräder - Vorne			POLY.C.
3.1 Räder: Lastrollen			POLY.C.
3.2 Reifengröße, hinten - Breite		mm	76
3.2 Räder Abmessung: Lenkräder - Durchmesser		mm	250
3.3 Reifengröße, hinten - Durchmesser		mm	82
3.3 Reifengröße, hinten - Breite		mm	80
3.4 Reifengröße: Stützräder vorn - Durchmesser		mm	100
3.4 Reifengröße: Stützräder vorn - Breite		mm	40
3.5 Reifengröße: hinten - Anzahl (X=angetrieben)		Anzahl	2
3.5 Reifengröße: vorne - Anzahl (X=angetrieben)		Anzahl	1x
3.6 Spurweite, vorn	b10	mm	530
3.7 Spurweite, hinten	b11	mm	375

Grundabmessungen

4.4 Hub	h3	mm	115
4.9 Höhe Deichsel in Fahrstellung max.	h14	mm	1238
4.9 Höhe Deichsel in Fahrstellung min.	h14	mm	725
4.15 Höhe gesenkt	h13	mm	85
4.19 Gesamtlänge	l1	mm	1210
4.20 Länge einschl. Gabelrücken	l2	mm	410
4.21 Gesamtbreite	b1	mm	720
4.22 Gabelzinkenmaße - Dicke	s	mm	55
4.22 Gabelzinkenmaße - Breite	e	mm	150
4.22 Gabelzinkenmaße - Länge	l	mm	800
4.25 Gabelaußenabstand	b5	mm	525
4.32 Bodenfreiheit, Mitte Radstand	m2	mm	30
4.34 Arbeitsgangbreite bei Palette 800x1200 quer	Ast	mm	1410
4.35 Wenderadius	Wa	mm	995

Leistungsdaten

5.1 Fahrgeschwindigkeit mit Last	Km/h	6
5.1 Fahrgeschwindigkeit ohne Last	Km/h	6
5.2 Hubgeschwindigkeit mit Last	m/s	0.03
5.2 Hubgeschwindigkeit ohne Last	m/s	0.04
5.3 Senkgeschwindigkeit mit Last	m/s	0.05
5.3 Senkgeschwindigkeit ohne Last	m/s	0.04
5.8 Max Steigfähigkeit mit Last	%	5
5.8 Max Steigfähigkeit ohne Last	%	10
5.10 Betriebsbremse		Elektrisch

E - motor

6.1 Fahrmotor, Leistung	kW	0.7
6.2 Hubmotor, Leistung	kW	1.0
Batterietyp	Type	AGM
6.4 Batteriespannung	V	24
6.4 Batterie Kapazität, min	Ah	85
6.4 Batterie Kapazität, max	Ah	85
6.5 Batteriegewicht, min	Kg	61
6.5 Batteriegewicht, max	Kg	61
6.6 Energieverbrauch nach VDI-Zyklus	kWh/h	0.28
8.4 Schalldruckpegel, Fahrerohr	dB(A)	59

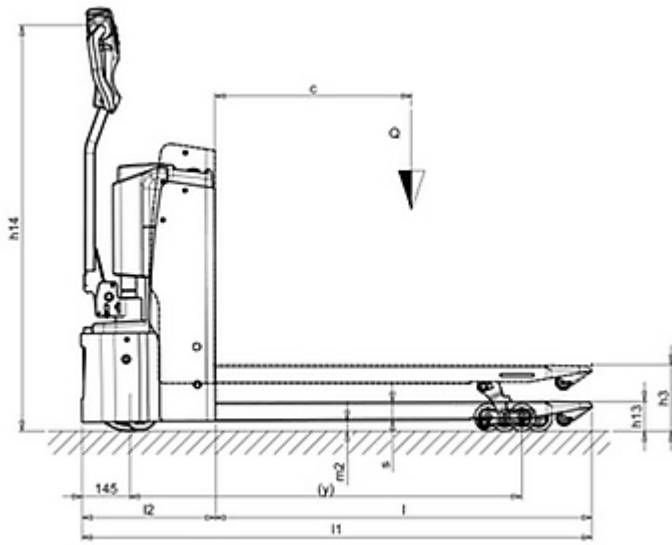
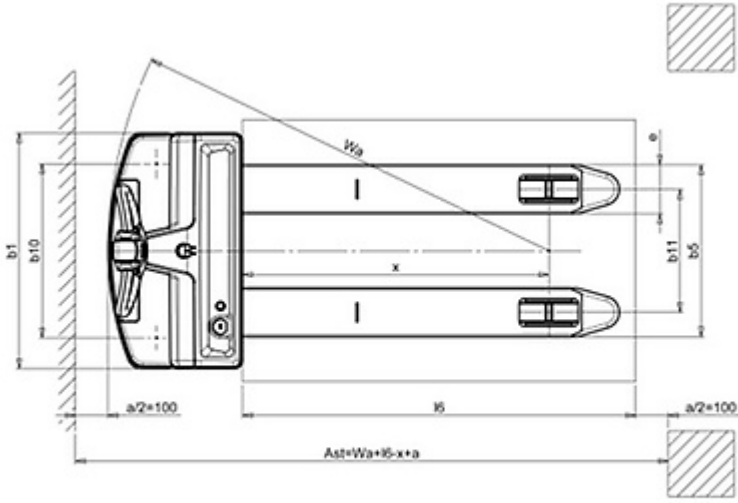

The information is aligned with the Data file at the time of download. Printed on 07/02/2019 (ID 9030)

©2019 | PR INDUSTRIAL s.r.l. | All rights reserved | Image shown may not reflect actual package. Specifications subject to change without notice

