

QX20 AC S2 1000X680

THE PROFESSIONAL CHOICE



QX20

The QX pallet truck series meets the needs of a vast number of applications guaranteeing high performance, even during the heaviest operations. The AC technology introduced in the traction motor promotes high energy efficiency and a longer battery charging duration; the absence of brushes in the motor and the simpler structure of the motor increase system reliability.

MOTOR WHEEL AND STABILIZING WHEELS

The motor wheel equipped with AC technology guarantees an excellent speed control system with or without load on board (6 km/h). Two stabilizing wheels also enable movement even on more difficult surfaces, thus guaranteeing maximum stability in any condition of use.

FORKS AND CONNECTION

The structure of QX pallet trucks is designed to guarantee maximum solidity and reliability: front forks are made of very thick cast iron just like clevis and other connecting rod parts. Impact on pallets and difficult surfaces is no longer a problem!

AC
QX 20



TILLER

- Ergonomic tiller.
- Luminous indicator for battery state control.
- Butterfly valves for traction control.
- Safety pushbutton with warning buzzer.
- Forks way up/down control positioned on both sides of the handle.
- “Tortoise” pushbutton for slow motion, which allows for the carrying out of operations with the tiller in vertical position.
- Ideal for running in confined spaces.



AC TECHNOLOGY

AC technology guarantees more energy efficiency and longer battery charging duration, thus reducing maintenance cost. Furthermore the absence of brushes in the motor and the simpler motor structure increase system reliability.



ROLLERS

Standard configuration provided with single polyurethane rollers. Available tandem rollers as optional.



Kennzeichen

1.1 Hersteller			LIFTER
Lift			ELECTRIC
1.3 Antrieb			ELECTRIC
1.4 Bedienung			Begleitend
1.5 Tragfähigkeit	Q	Kg	2000
1.6 Lastschwerpunkt	c	mm	500
1.8 Lastabstand	x	mm	823
1.9 Radstand	y	mm	1223

Gewicht

2.1 Eigengewicht (inkl. Batterie)		Kg	504
2.2 Achslast mit Last hinten		Kg	1581
2.2 Achslast, mit Last vorne		Kg	923
2.3 Achslast mit Last vorne		Kg	383
2.3 Achslast mit Last hinten		Kg	121

Fahrwerk/Räder

3.1 Räder: Lenkräder			POLY.C.
3.1 Bereifung: Stützräder - Vorne			POLY.C.
3.1 Räder: Lastrollen			POLY.C.
3.2 Reifengröße, hinten - Breite		mm	75
3.2 Räder Abmessung: Lenkräder - Durchmesser		mm	230
3.3 Reifengröße, hinten - Durchmesser		mm	85
3.3 Reifengröße, hinten - Breite		mm	90
3.4 Reifengröße: Stützräder vorn - Durchmesser		mm	100
3.4 Reifengröße: Stützräder vorn - Breite		mm	40
3.5 Reifengröße: hinten - Anzahl (X=angetrieben)		Anzahl	2
3.6 Spurweite, vorn	b10	mm	506
3.7 Spurweite, hinten	b11	mm	510

Grundabmessungen

4.4 Hub	h3	mm	115
4.9 Höhe Deichsel in Fahrstellung max.	h14	mm	1320
4.15 Höhe gesenkt	h13	mm	85
4.19 Gesamtlänge	l1	mm	1565
4.20 Länge einschl. Gabelrücken	l2	mm	565
4.21 Gesamtbreite	b1	mm	716
4.22 Gabelzinkenmaße - Dicke	s	mm	55
4.22 Gabelzinkenmaße - Breite	e	mm	170
4.22 Gabelzinkenmaße - Länge	l	mm	1000
4.25 Gabelaußenabstand	b5	mm	680
4.32 Bodenfreiheit, Mitte Radstand	m2	mm	30
4.34 Arbeitsgangbreite bei Palette 800x1200 quer	Ast	mm	1802
4.35 Wenderadius	Wa	mm	1425

Leistungsdaten

5.1 Fahrgeschwindigkeit mit Last	Km/h	6.0
5.1 Fahrgeschwindigkeit ohne Last	Km/h	6.0
5.2 Hubgeschwindigkeit mit Last	m/s	0.04
5.2 Hubgeschwindigkeit ohne Last	m/s	0.05
5.3 Senkgeschwindigkeit mit Last	m/s	0.05
5.3 Senkgeschwindigkeit ohne Last	m/s	0.04
5.8 Max Steigfähigkeit mit Last	%	10
5.8 Max Steigfähigkeit ohne Last	%	20
5.10 Betriebsbremse		REVERSE CURRENT BRAKING

E - motor

6.1 Fahrmotor, Leistung	kW	1.5
6.2 Hubmotor, Leistung	kW	2.2
Batterietyp	Type	TRACTION
6.4 Batteriespannung	V	24
6.4 Batterie Kapazität, min	Ah	180
6.4 Batterie Kapazität, max	Ah	230
6.5 Batteriegewicht, min	Kg	180
6.5 Batteriegewicht, max	Kg	216

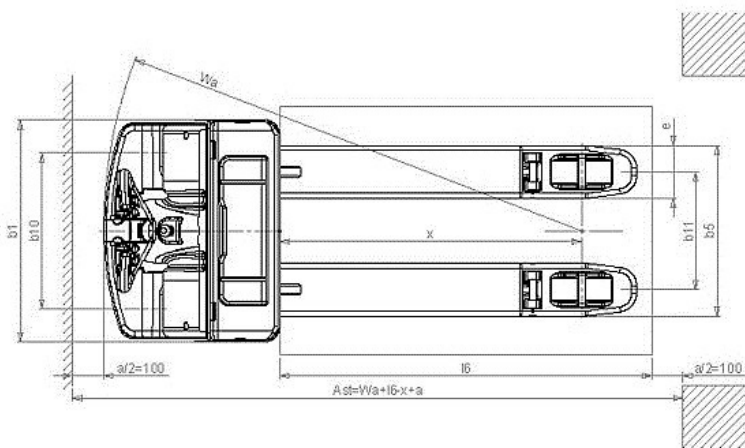
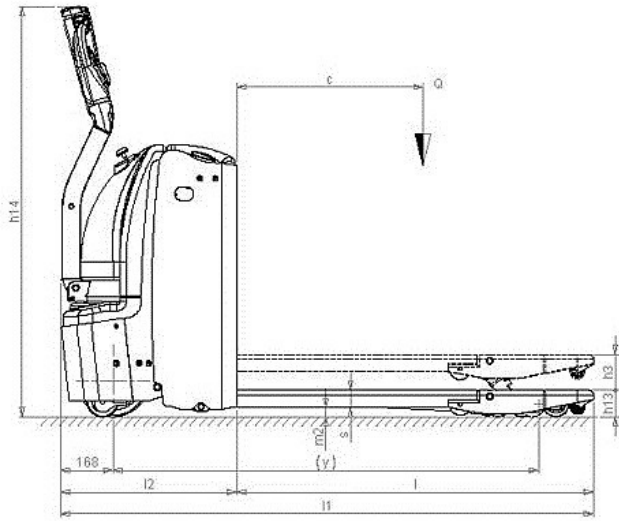

The information is aligned with the Data file at the time of download. Printed on 18/03/2019 (ID 489)

©2019 | PR INDUSTRIAL s.r.l. | All rights reserved | Image shown may not reflect actual package. Specifications subject to change without notice

